

**Figures for
Introduction to Complex Analysis**

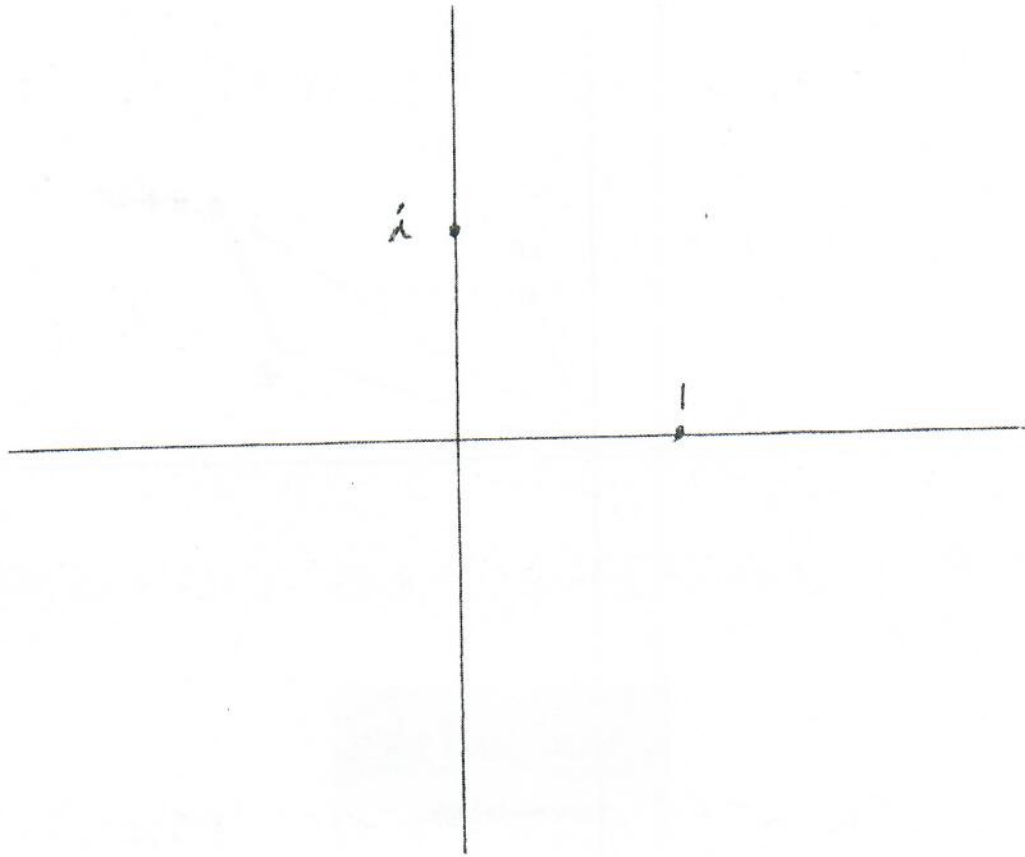

Figure 0.1

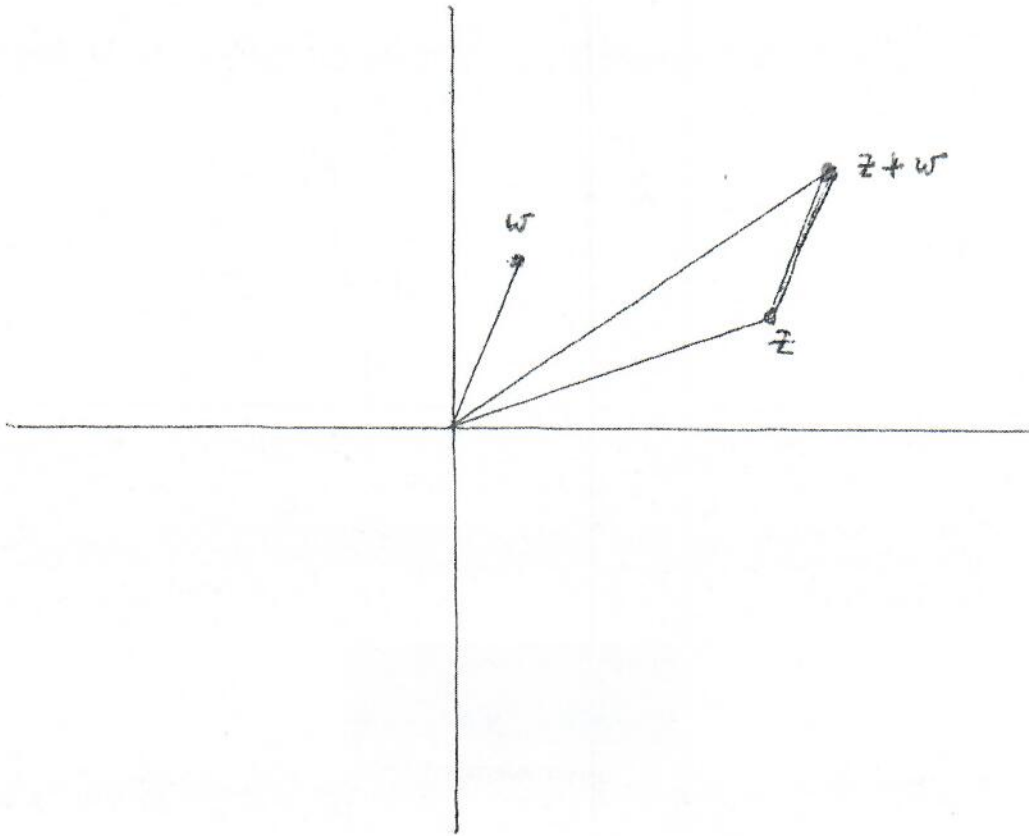

Figure 0.2

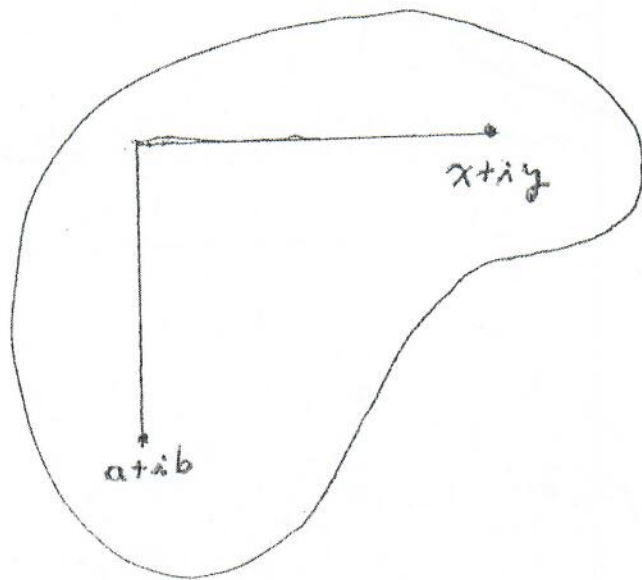

Figure 1.1

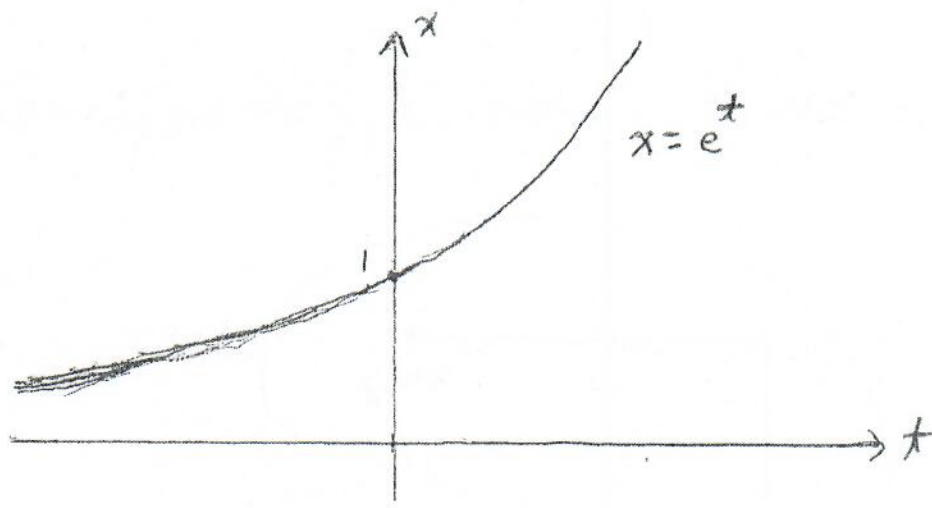

Figure 3.1

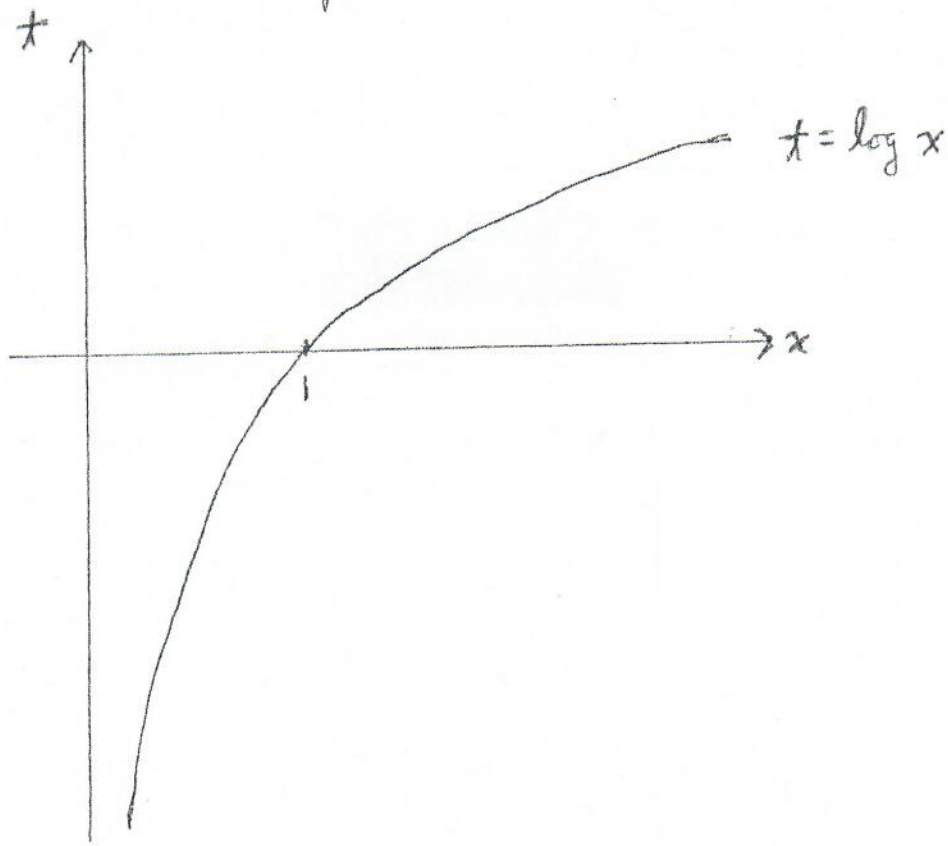

Figure 3.2

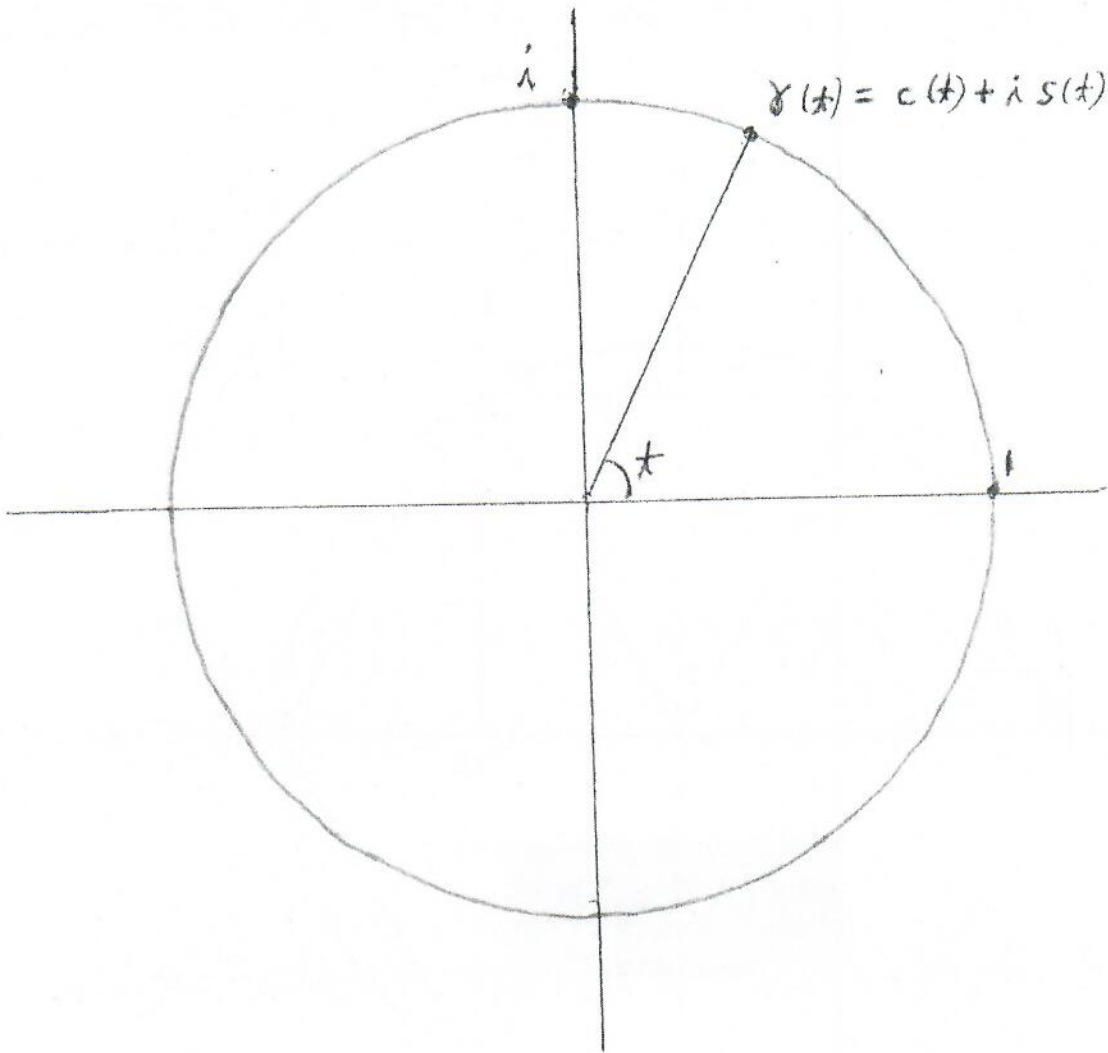

Figure 3.3

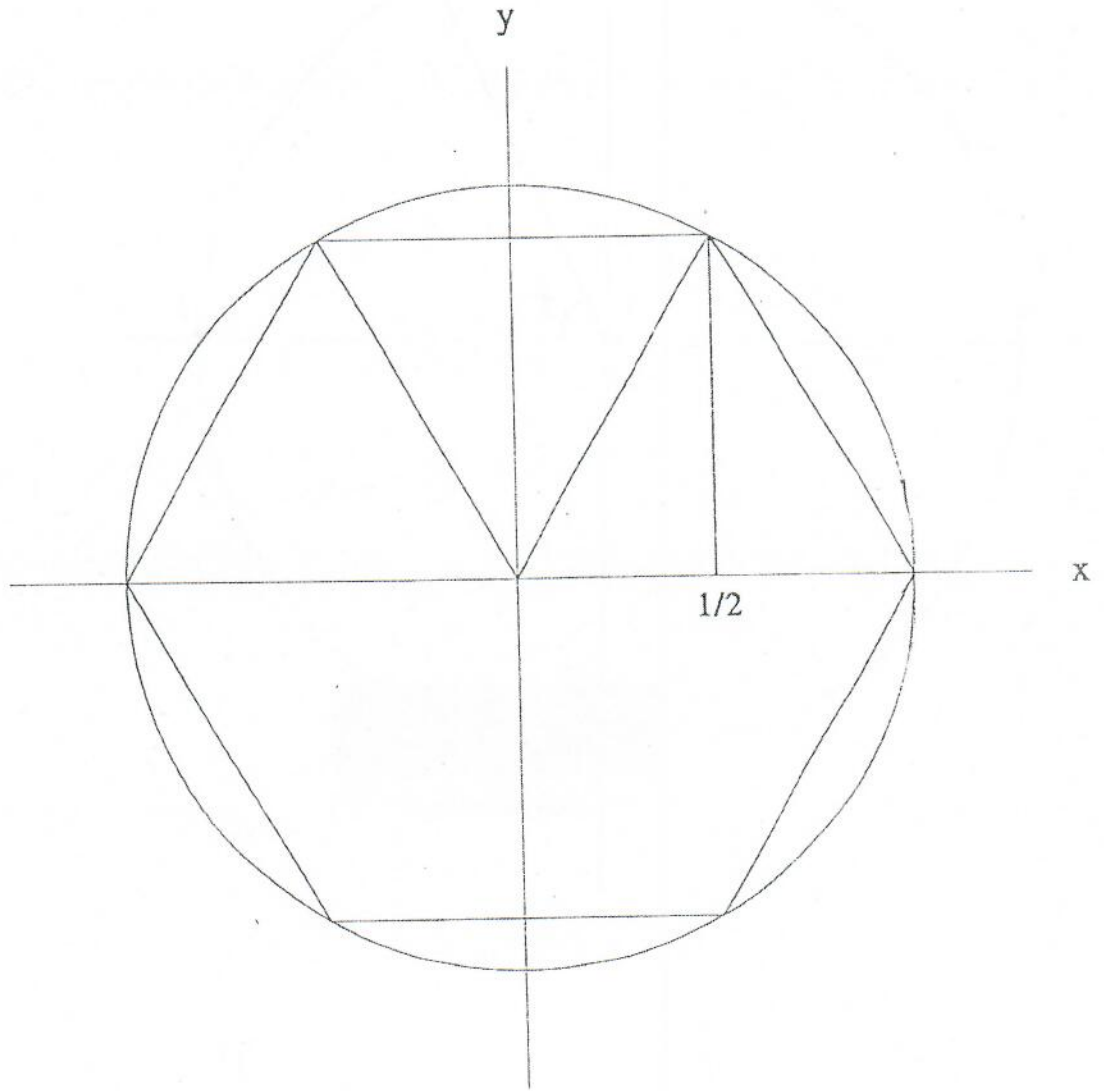

Fig. 3.4

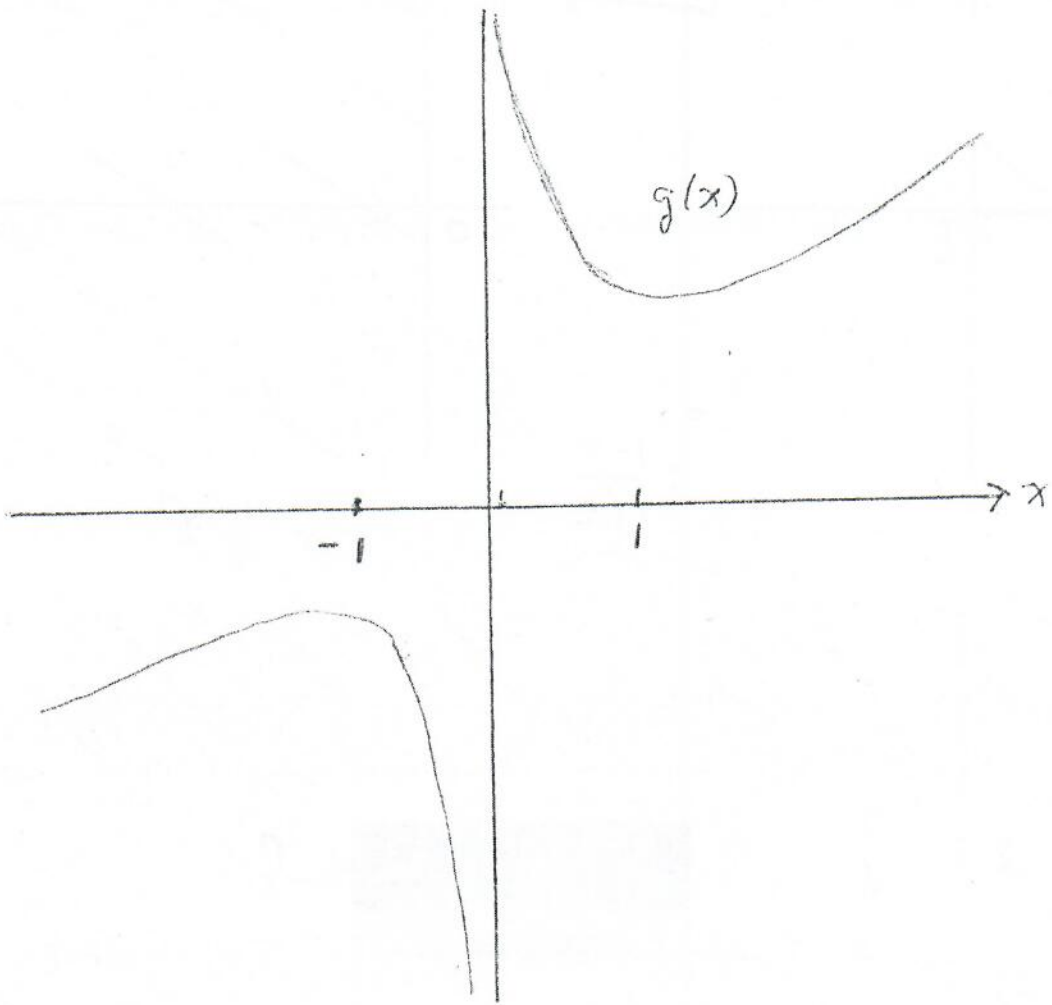

Figure 4.1

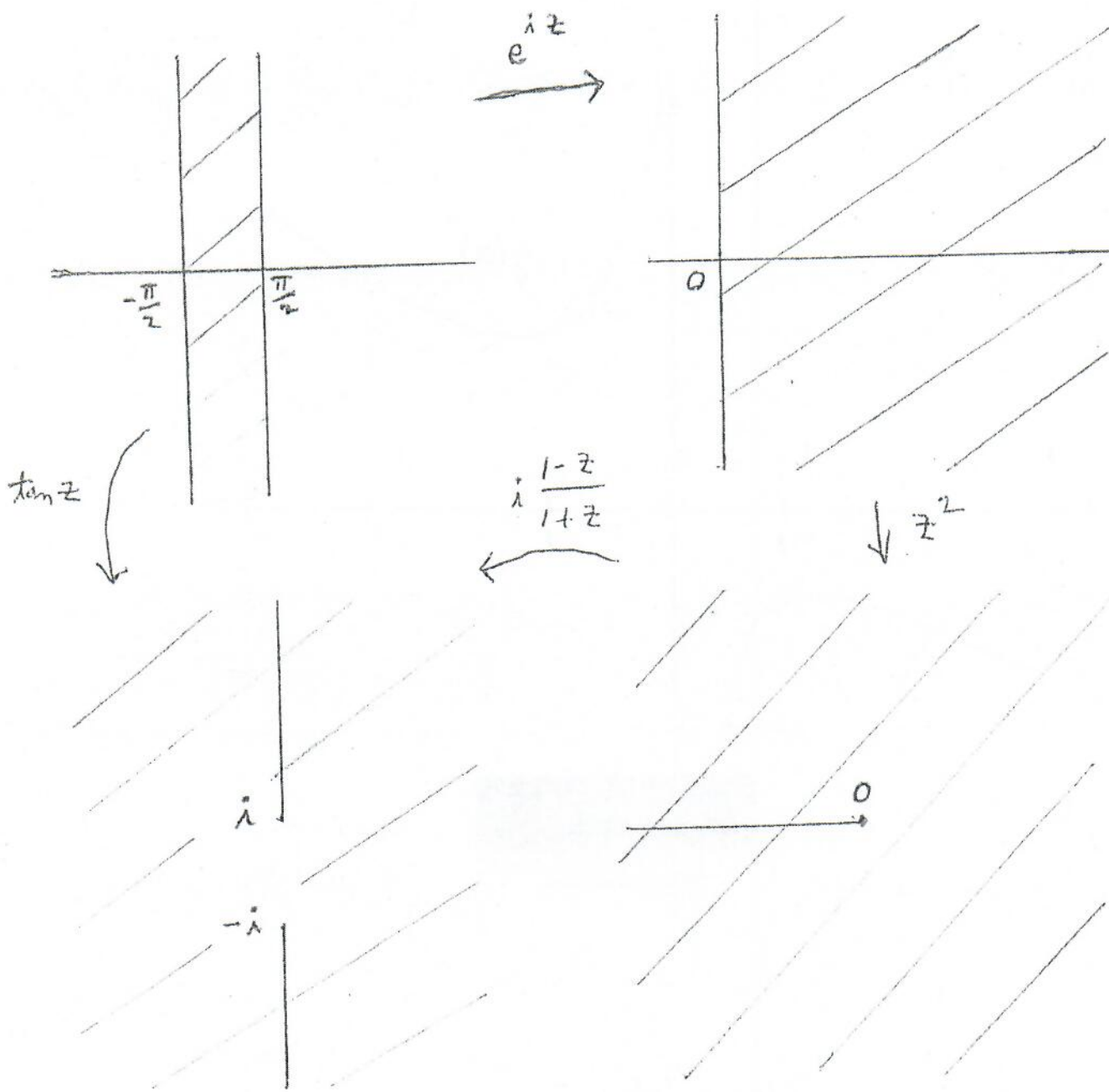

Figure 4.2

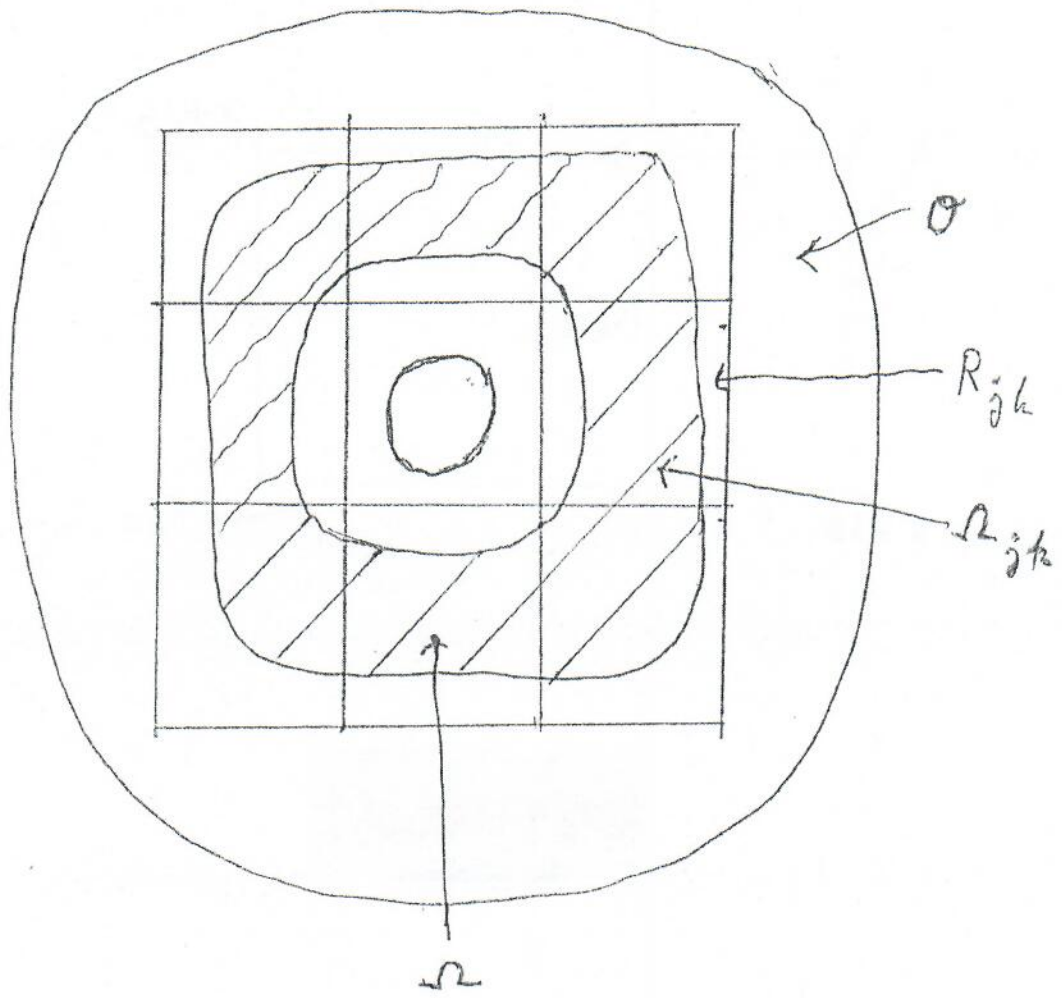

Figure 5.1

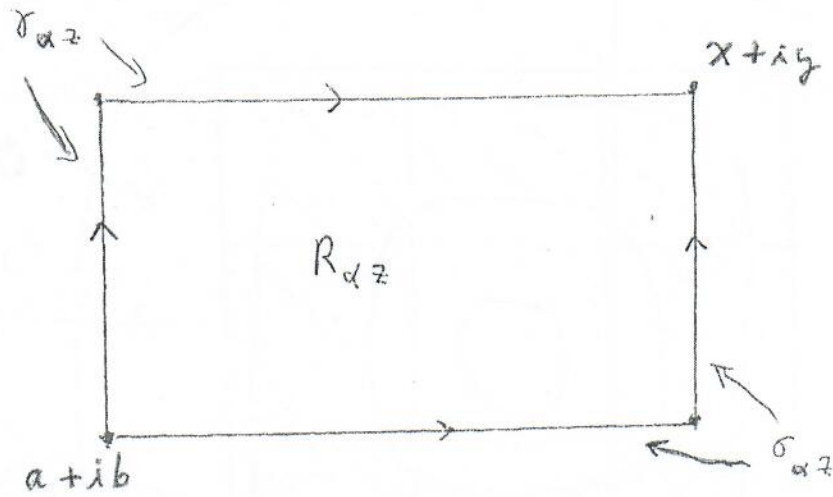
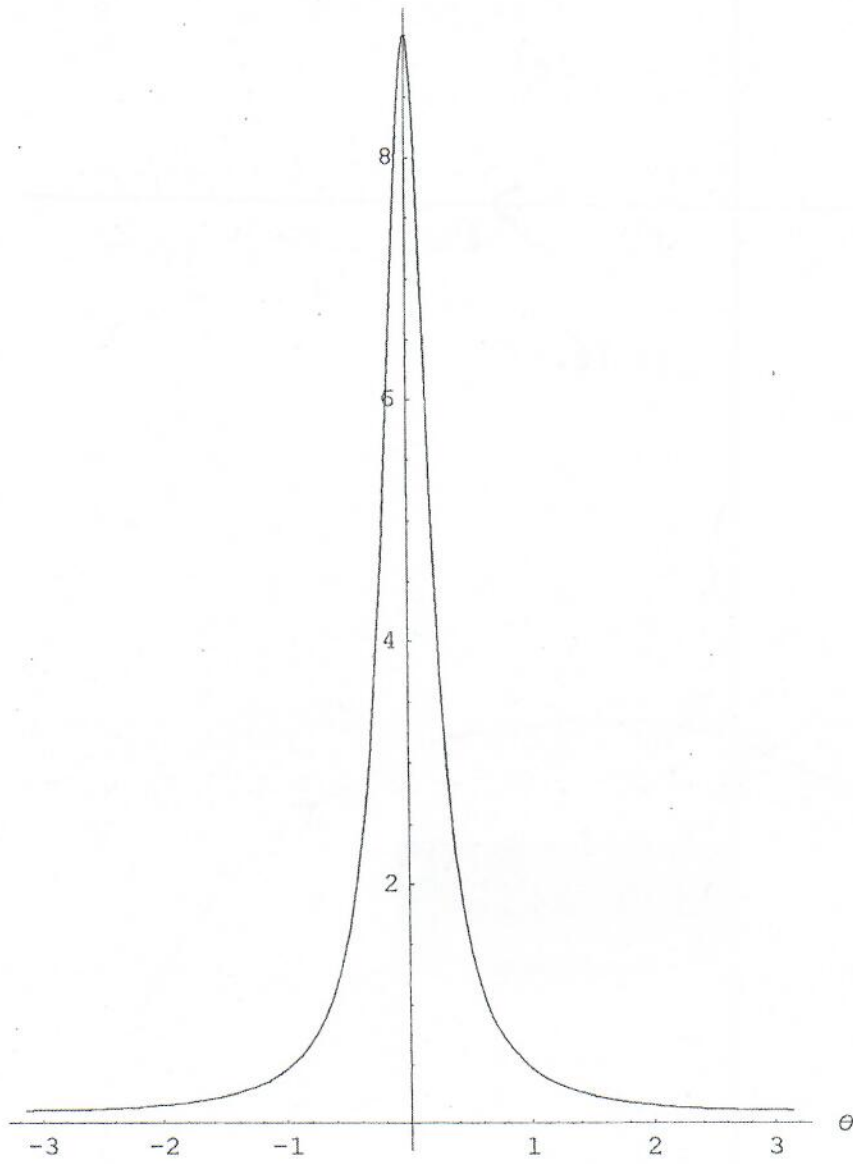

Figure 7.1

Fig. 13.1



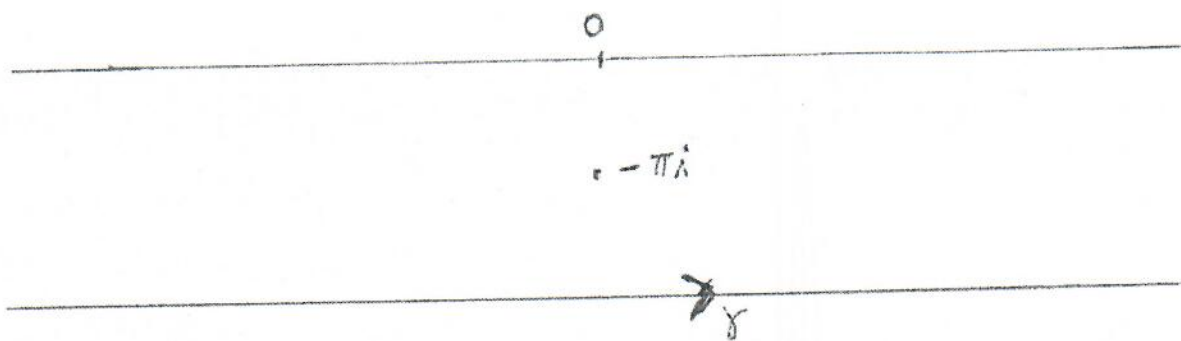

Figure 16.1

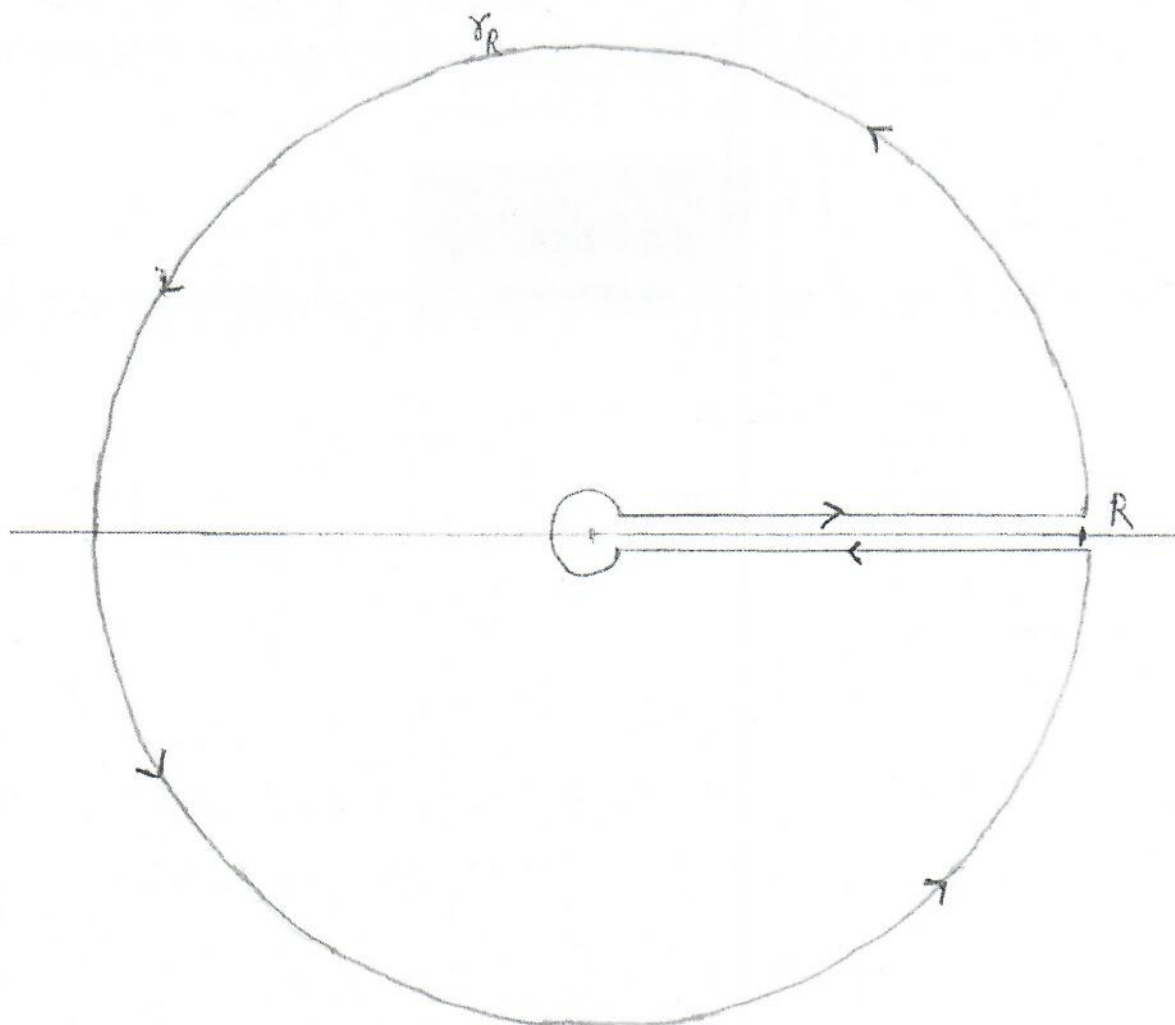

Figure 16.2

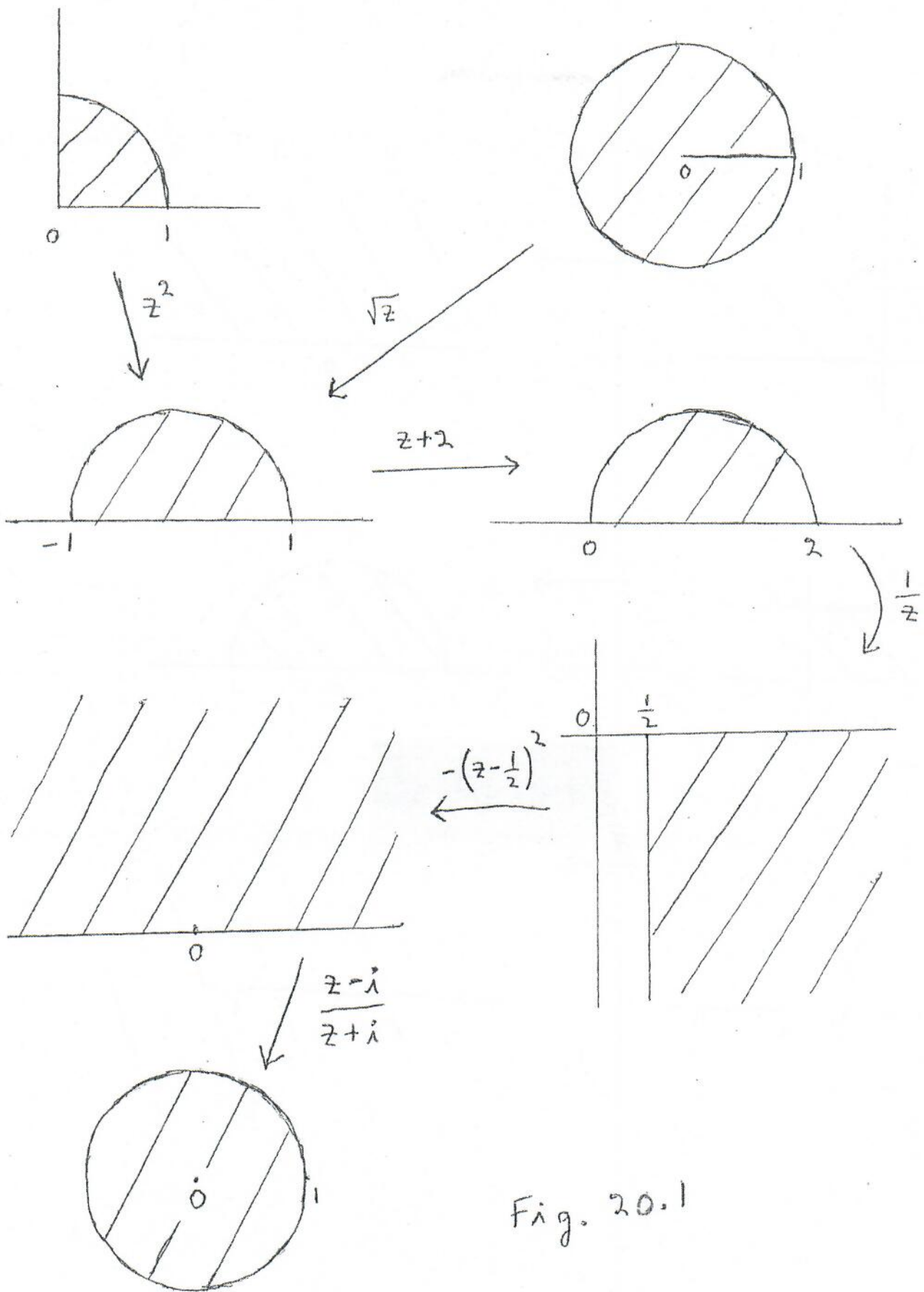

Fig. 20.1

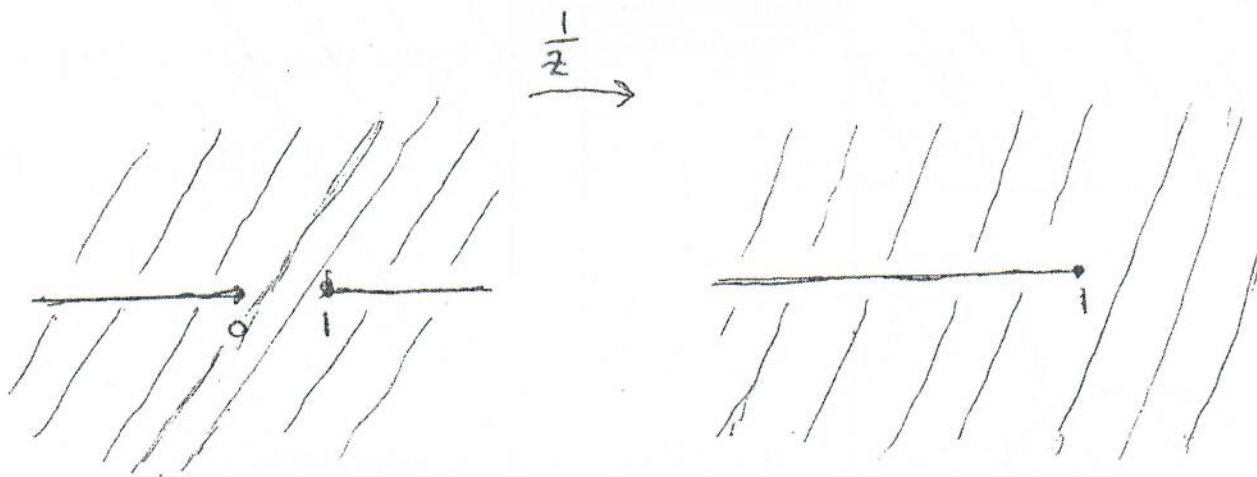
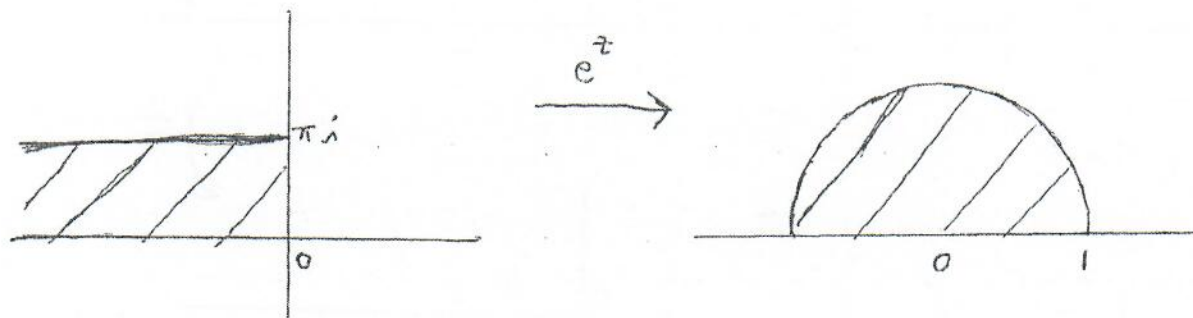
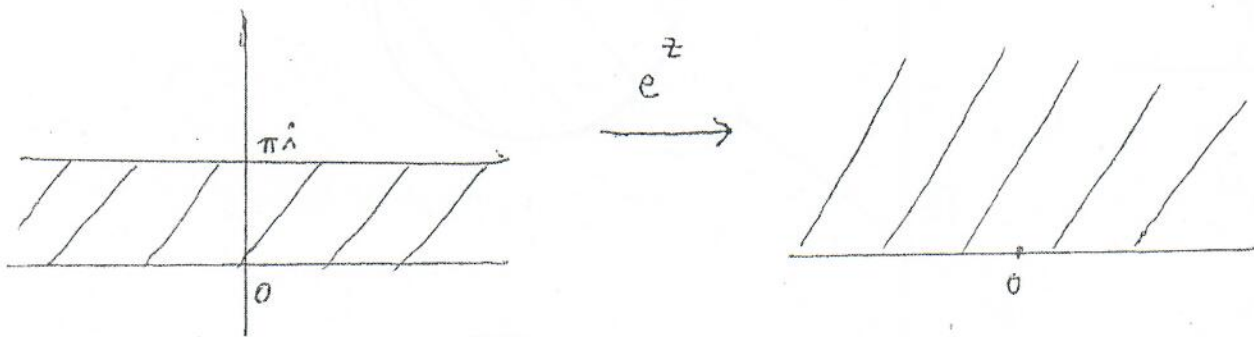

Fig. 20.2

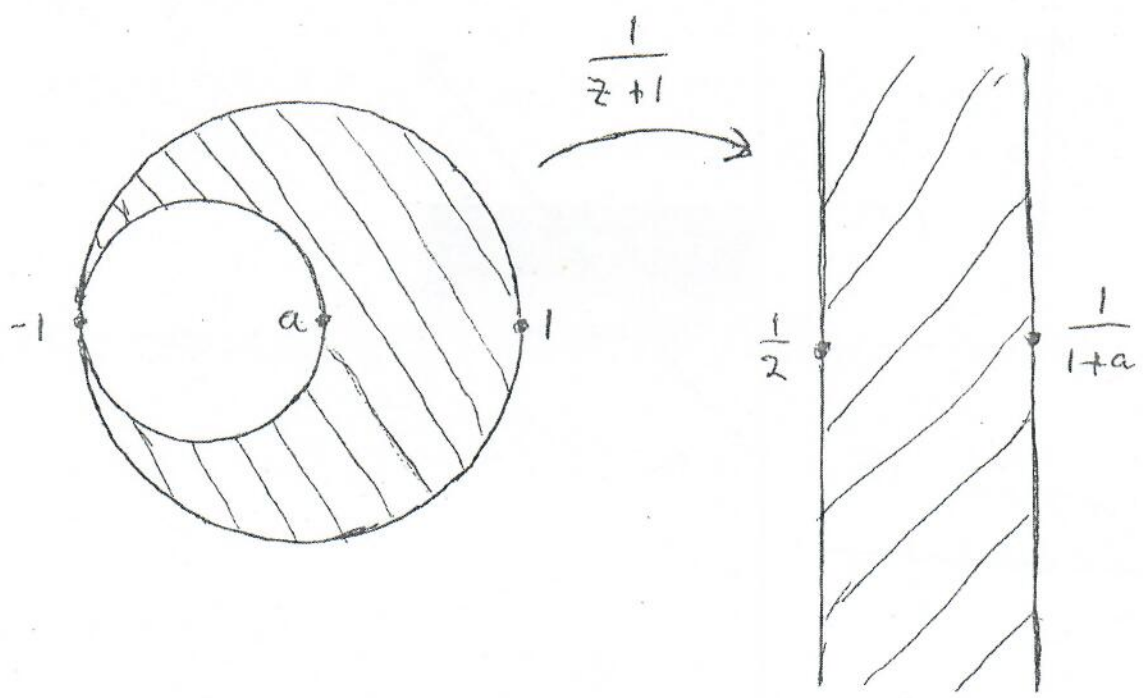
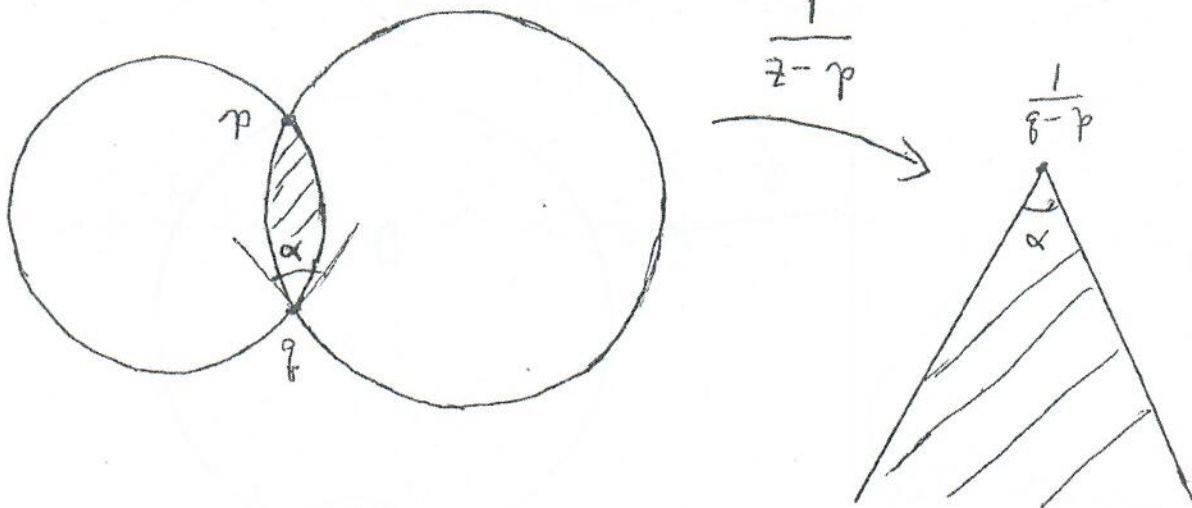

Fig. 20.3

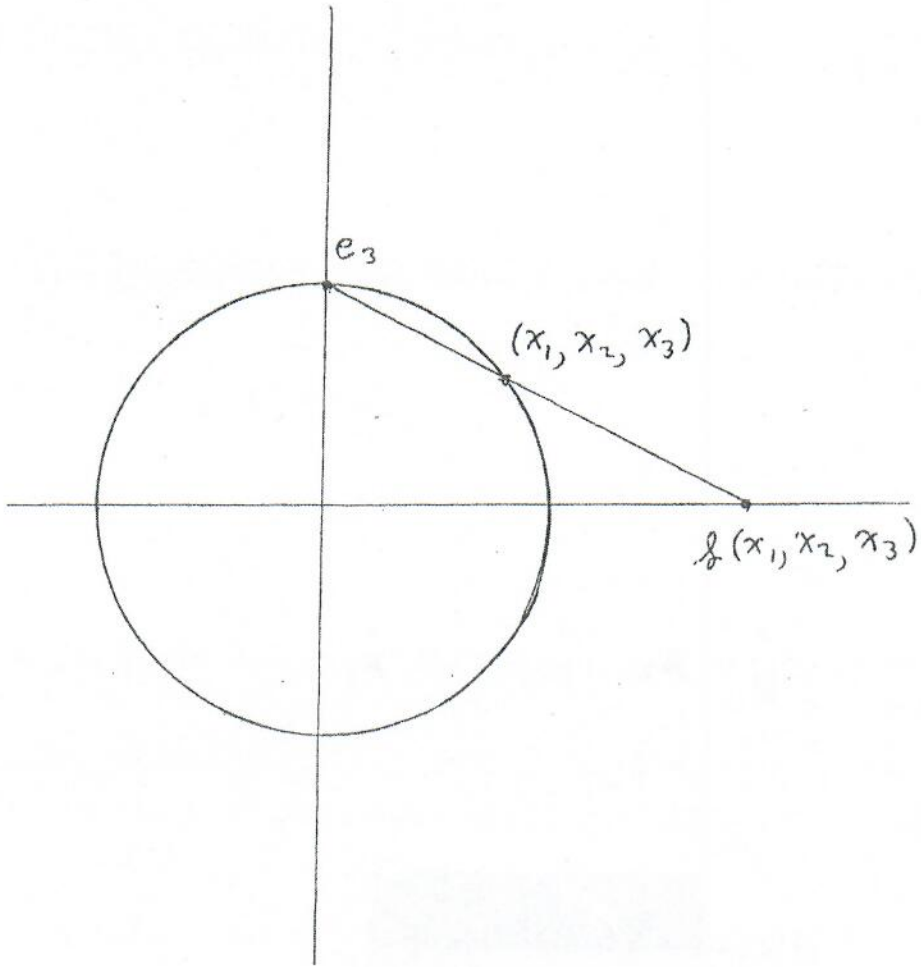

Fig. 22.1

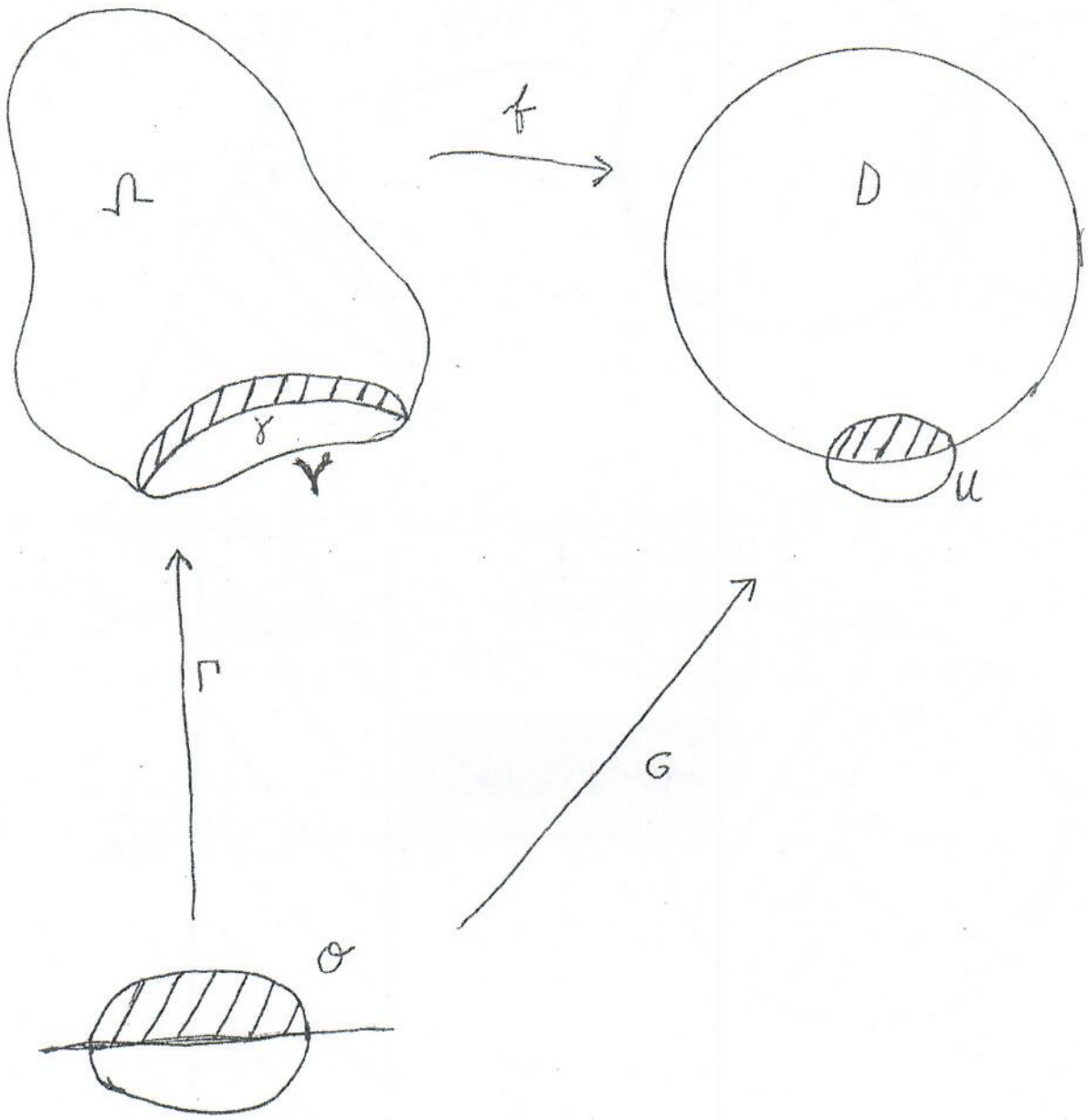

Fig. 24.1

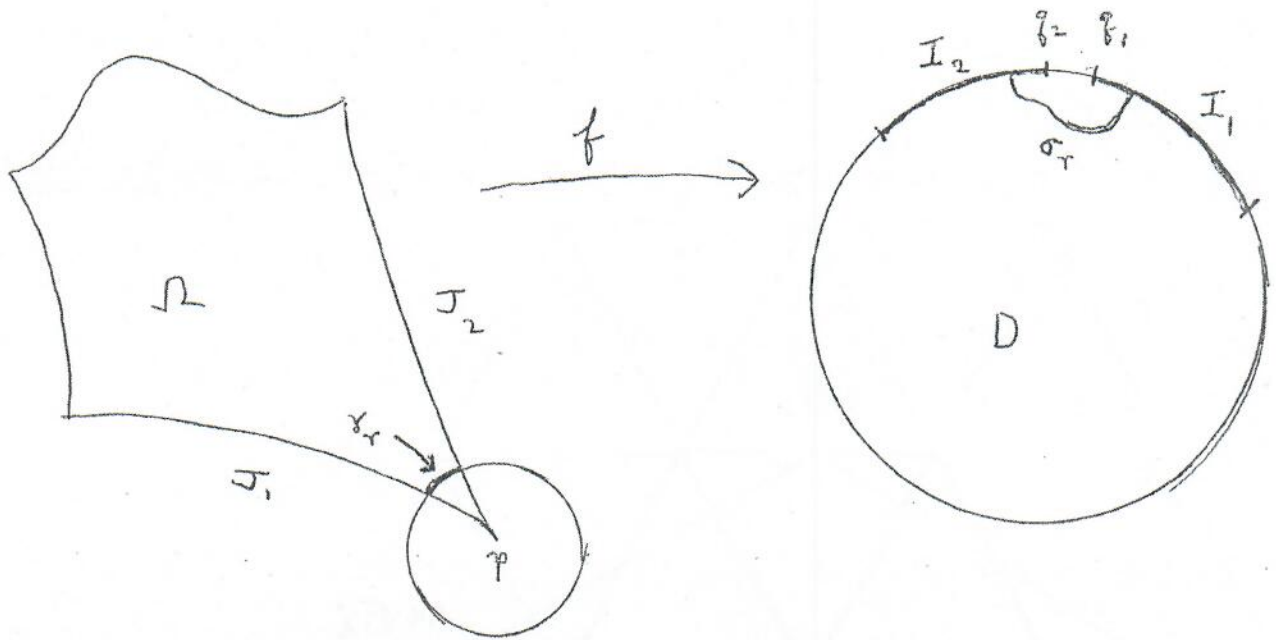

Fig. 24.2

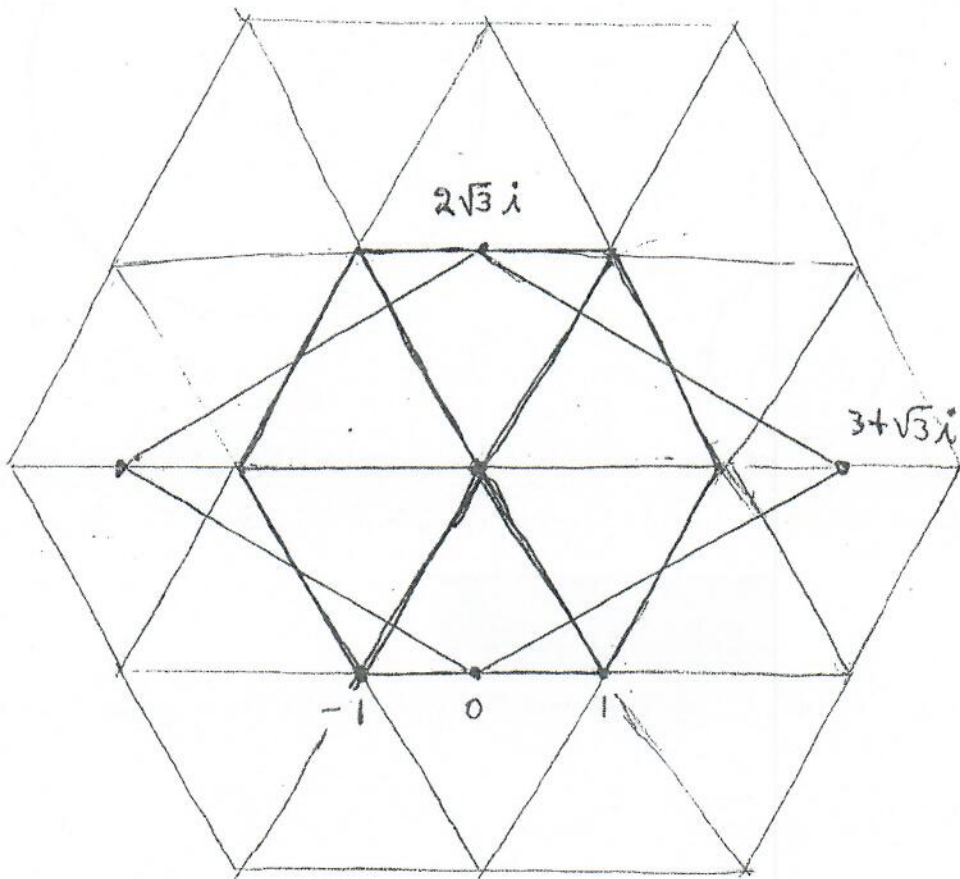

Fig. 24.3

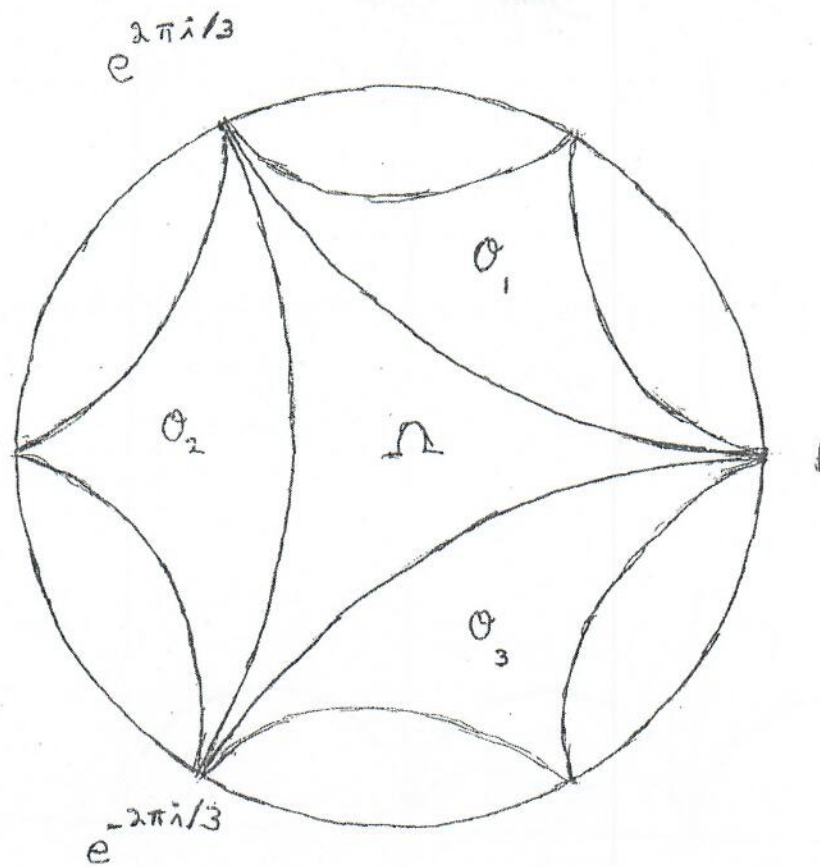

Fig. 26.1

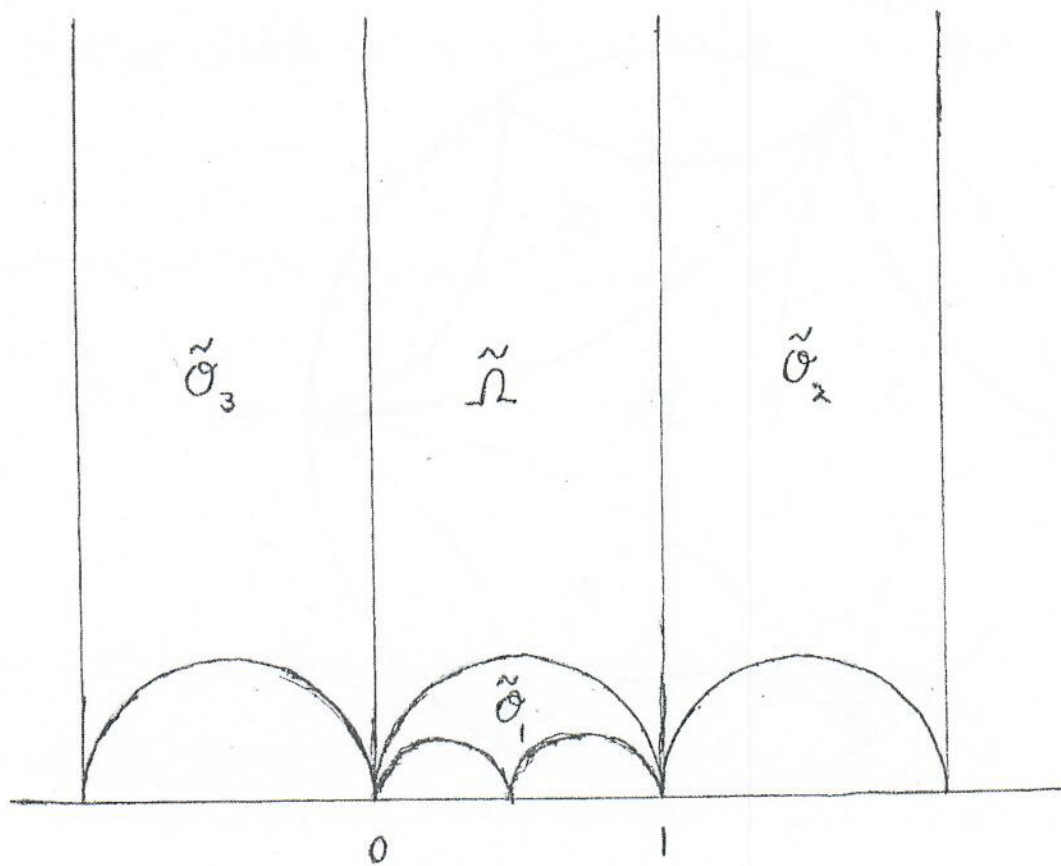

Fig. 26.2

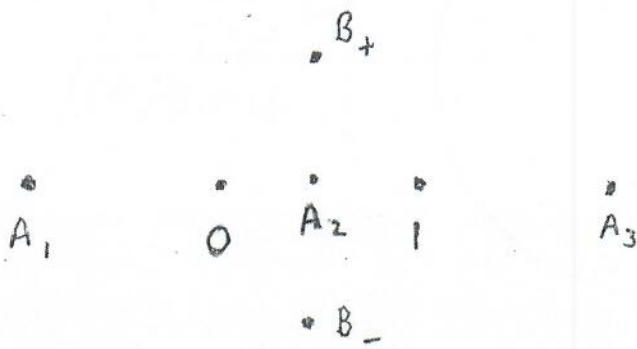

Figure 26.3

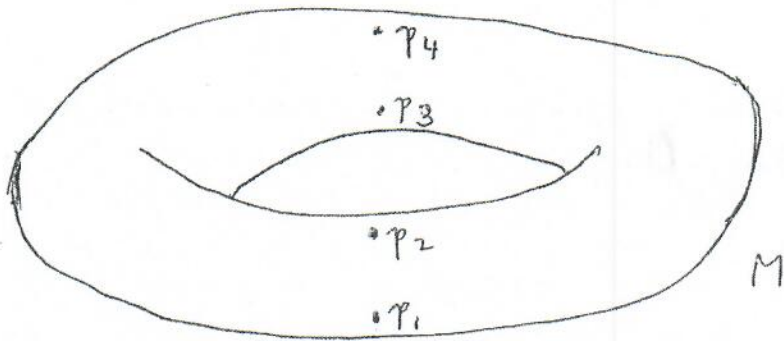
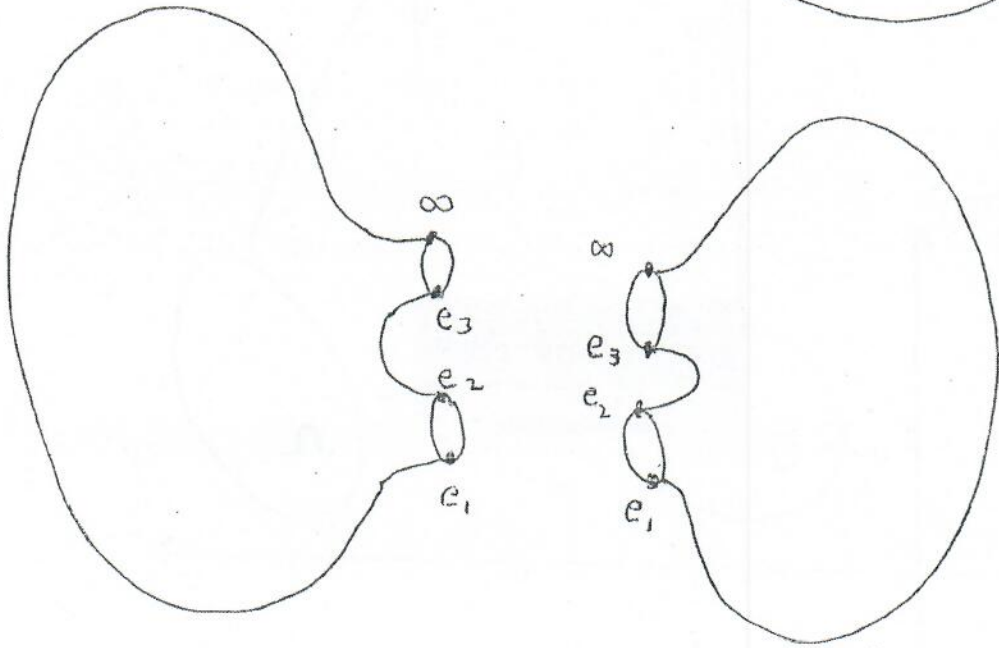
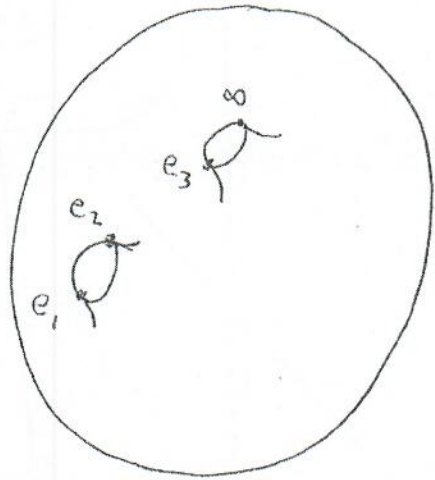
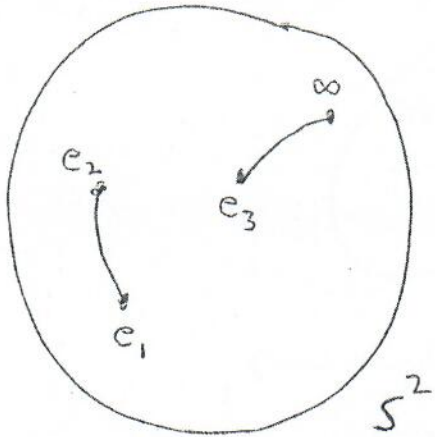

Fig. 34.1

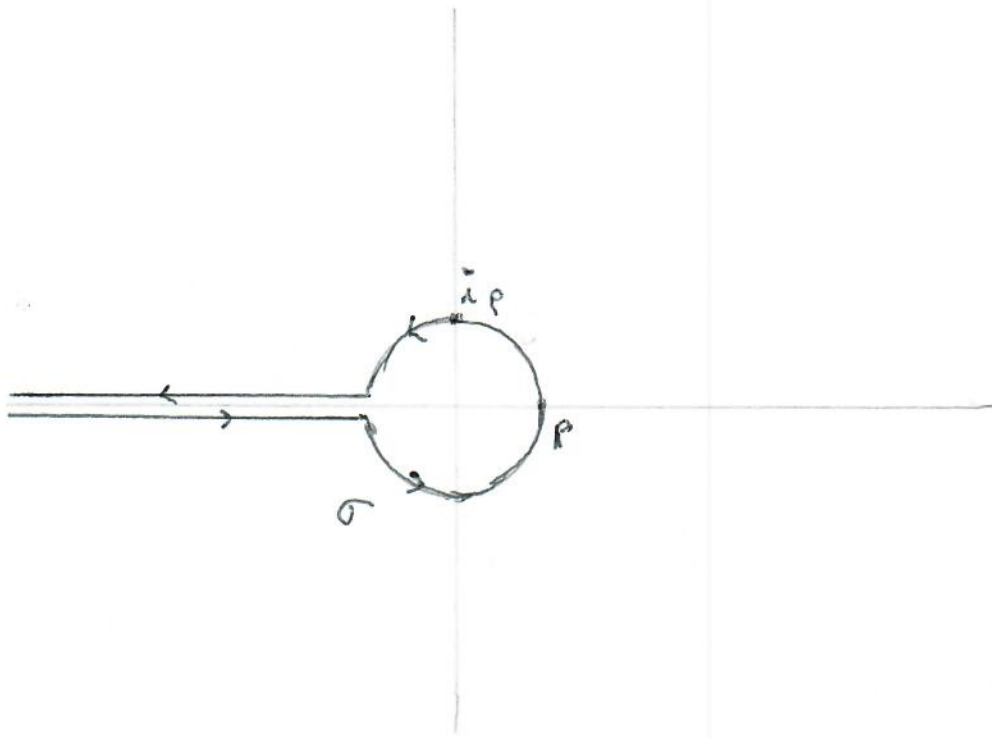

Figure 35.1

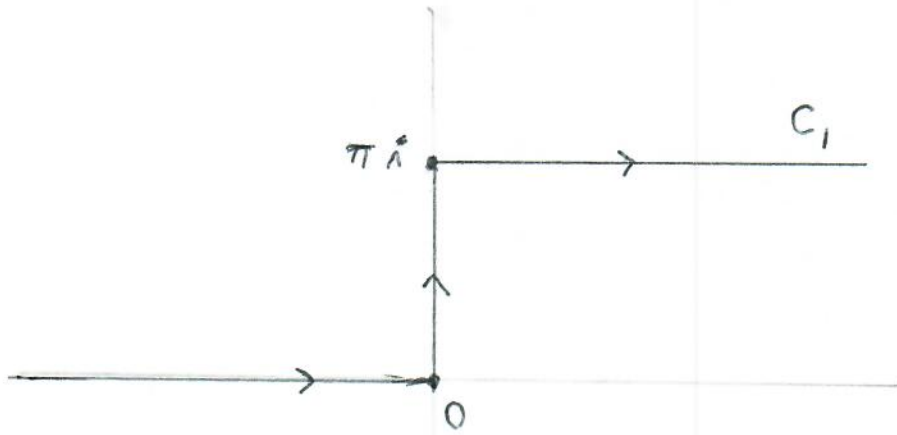

Figure 35.2

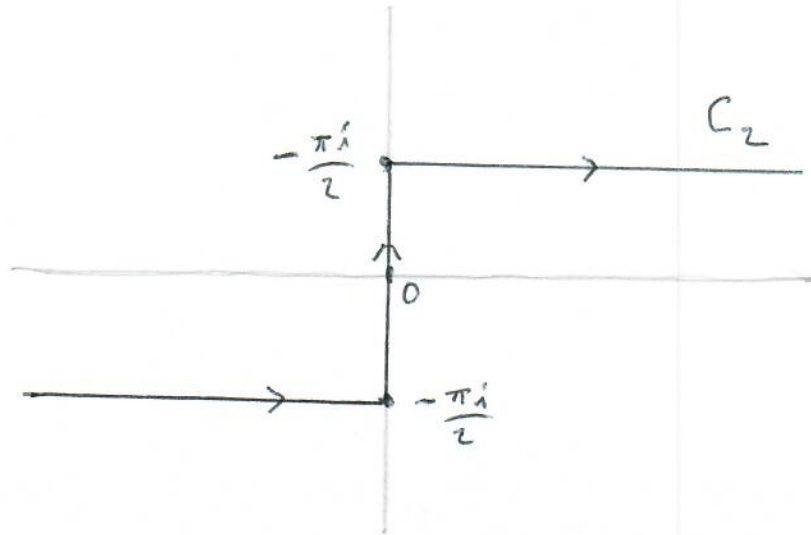

Figure 35.3

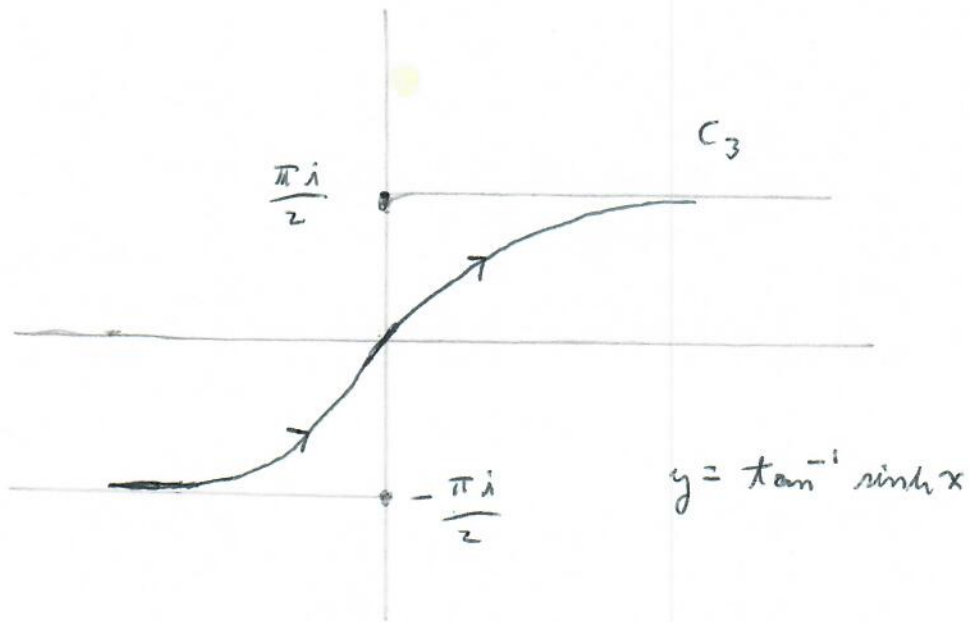

Figure 35.4

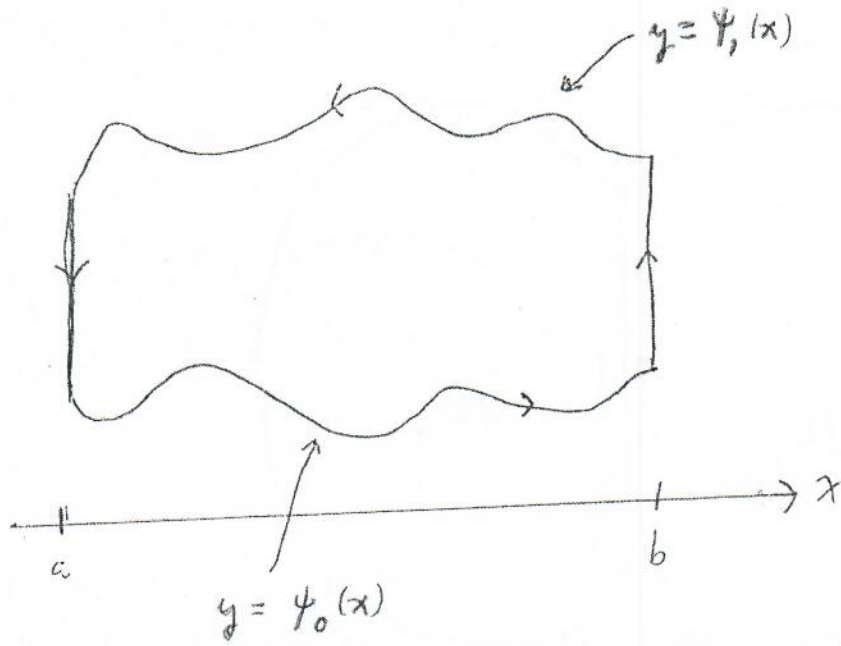

Figure C.1

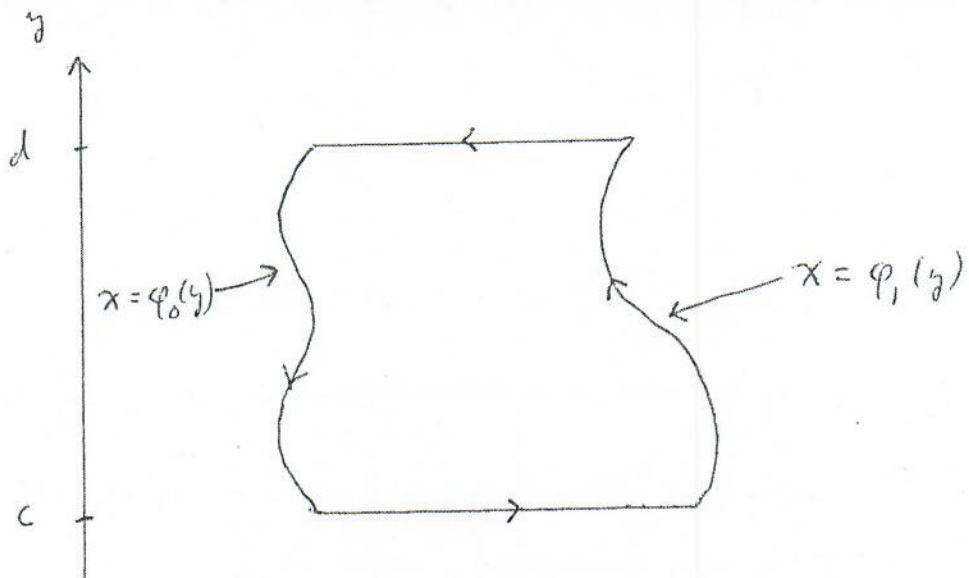

Figure C.2

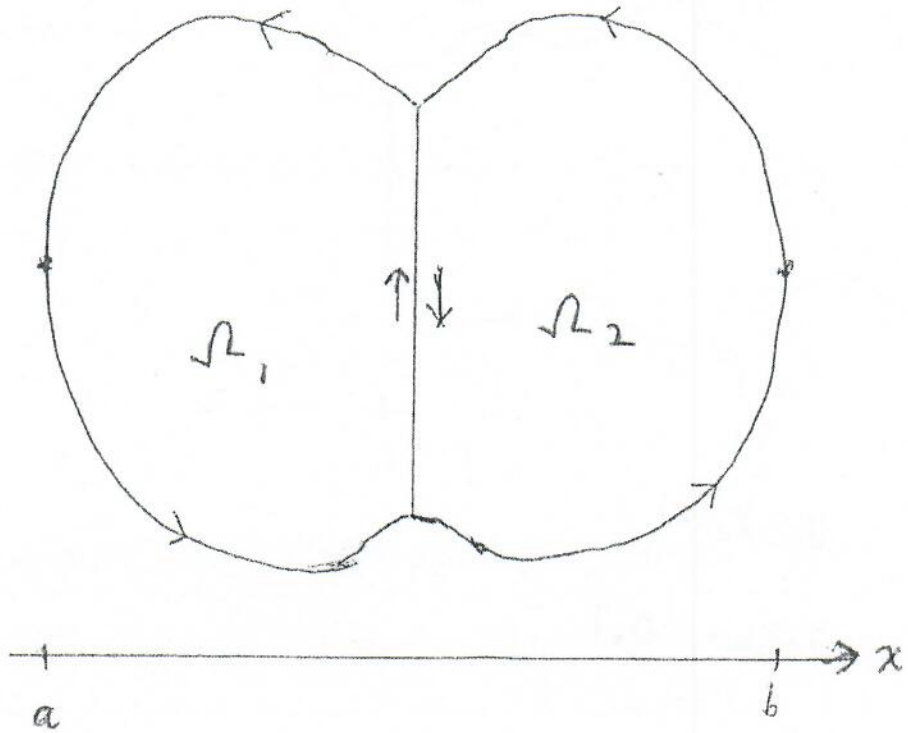

Figure C.3

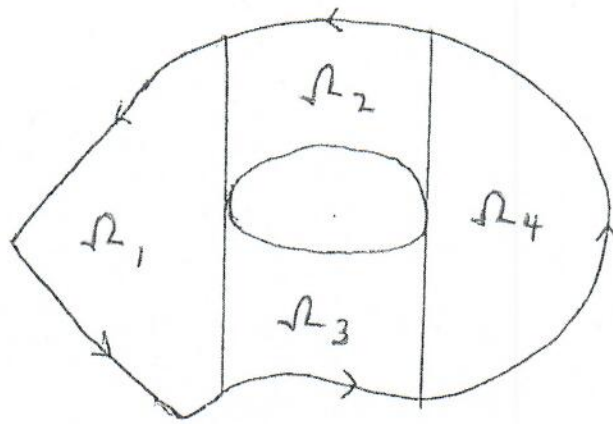

Figure C.4

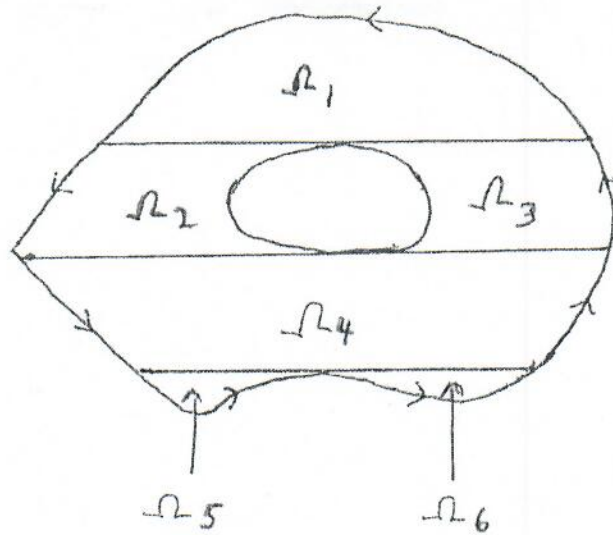

Figure C.5

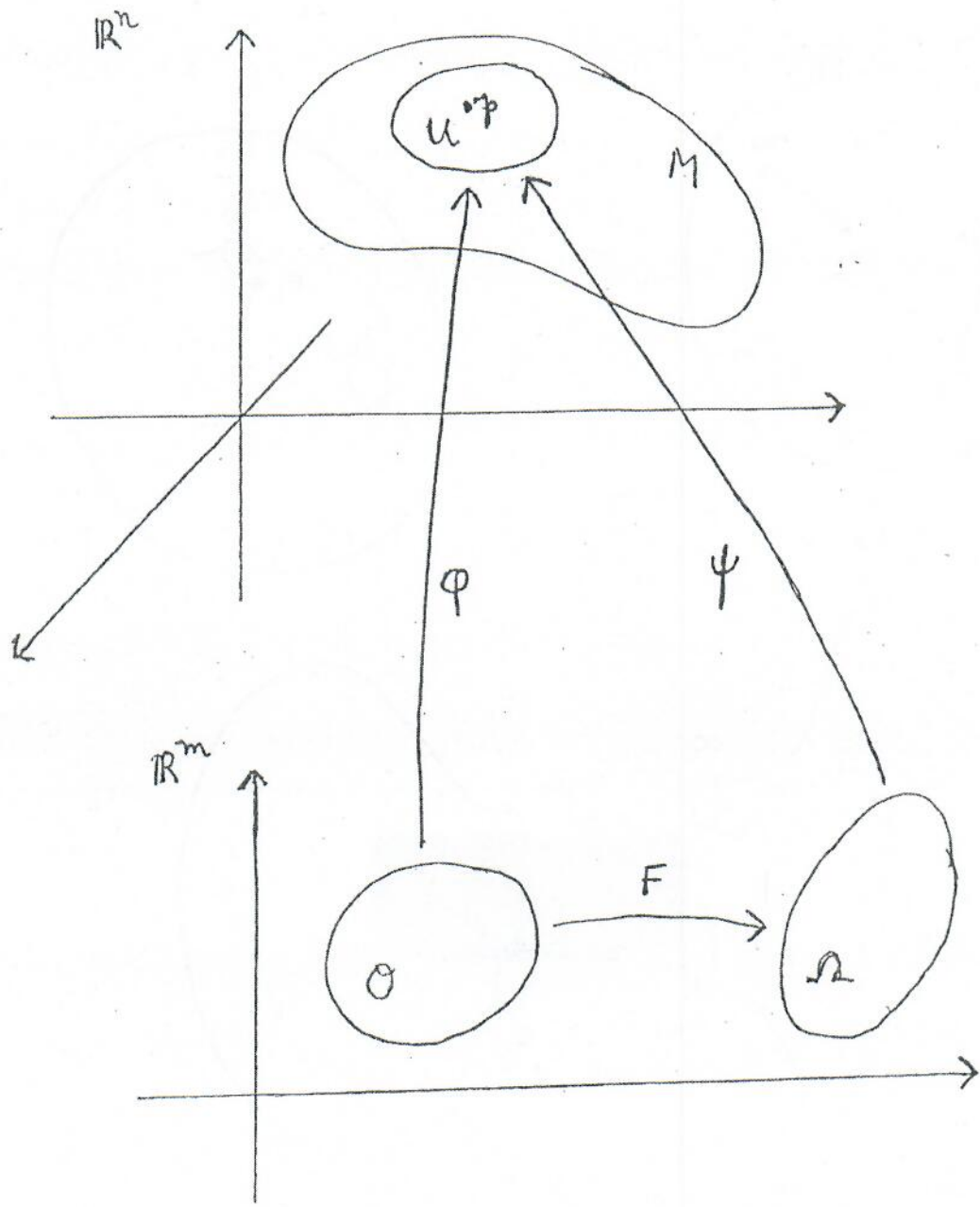

Fig. 0.1